

Product Catalog



CONTENTS

Curtain Tracks



Curtain Rods

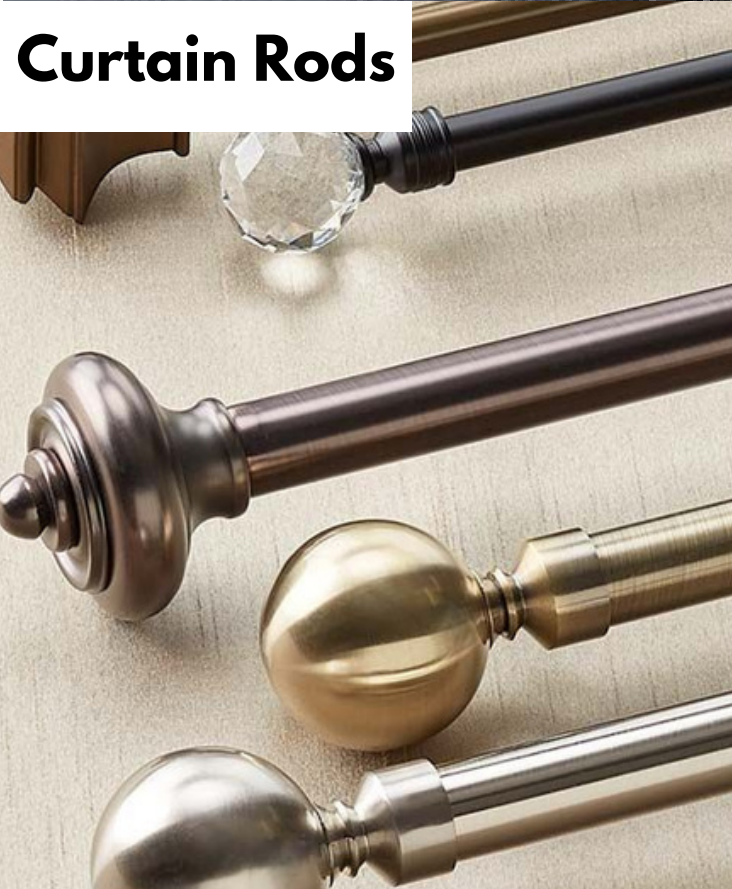

Blind Components



Motorized Solutions



Curtain Accessories

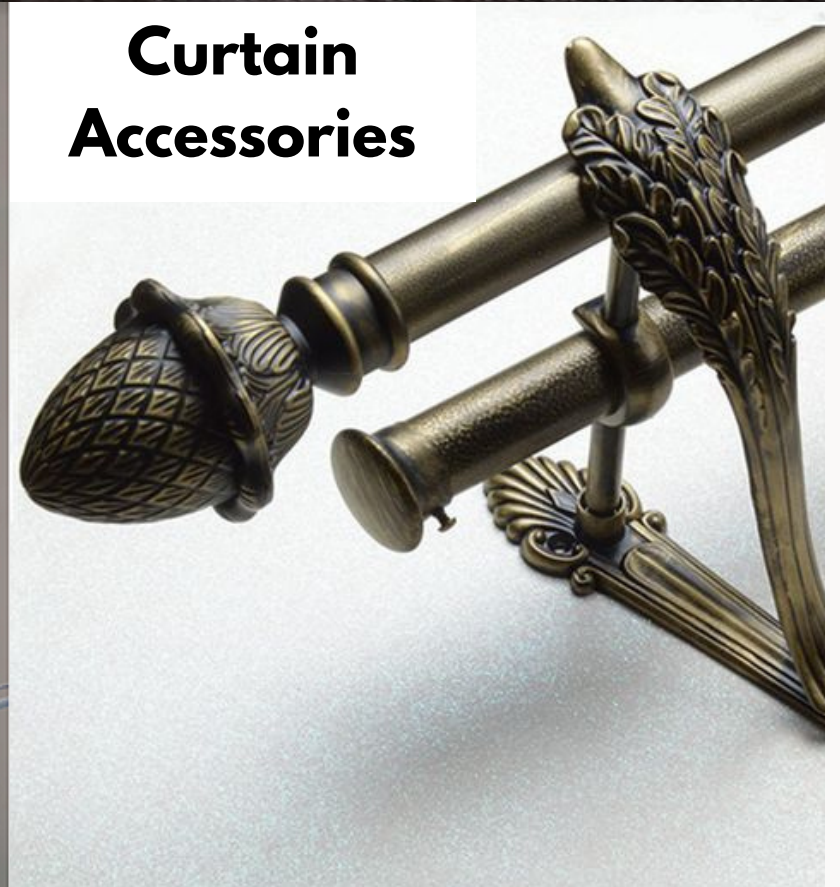

Curtain Tracks



M TRACK

White

Ivory

Black

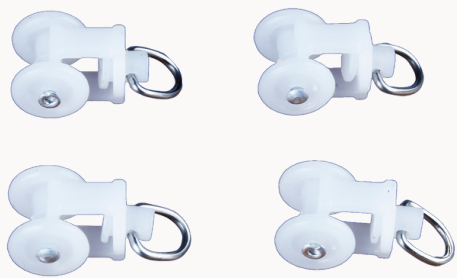

Runner

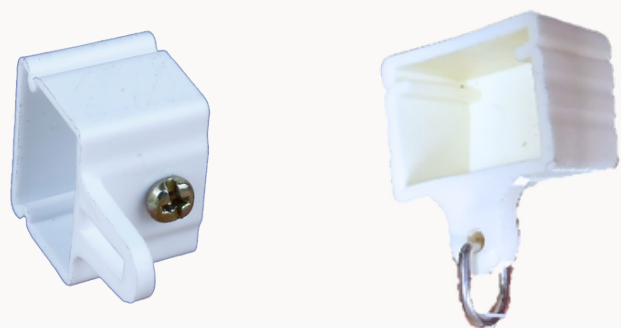

End Cap (Normal / With Hook)

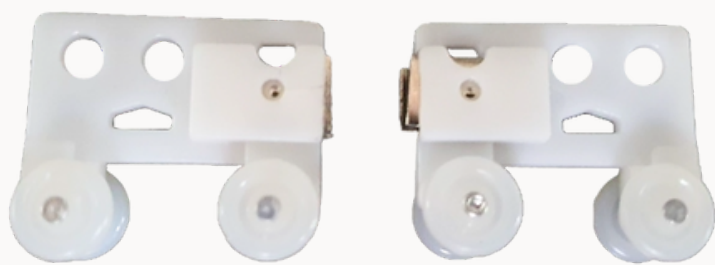

M Track Magnet

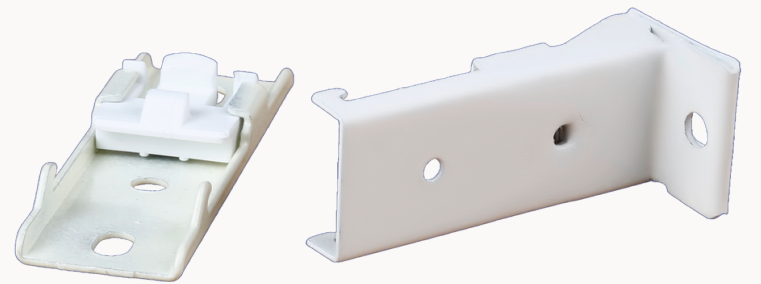

M Ceiling/Wall Bracket

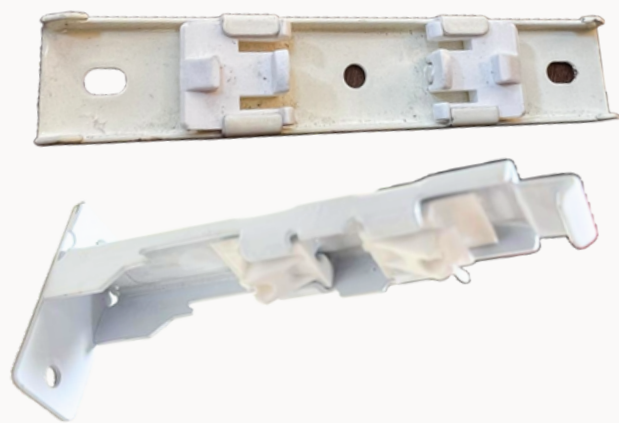

M Double Brackets

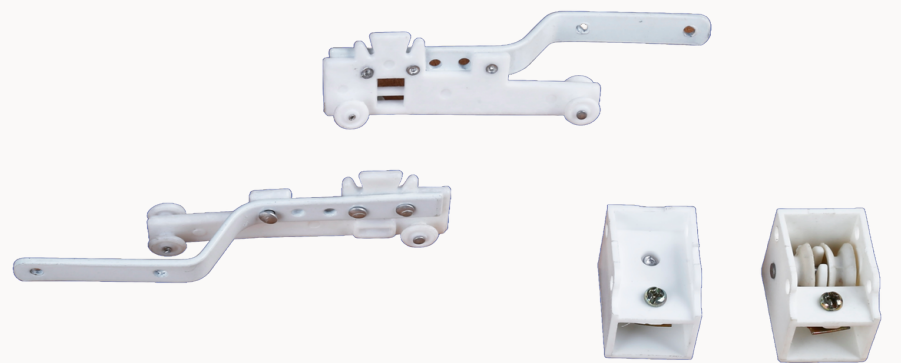

M Track Overlapper



M Runner (Heavy)

WEIGHT OPTIONS:

650GM/850GM/1KG/1.3KG
PER 15FT

CUSTOM LENGTH UP TO 16FT
AVAILABLE AGAINST ORDER

JUMBO TRACK

White

Ivory

Black



Jumbo Elbow



Jumbo Runner (Ivory/Blue)



Jumbo Bracket (#28)



Jumbo End Cap

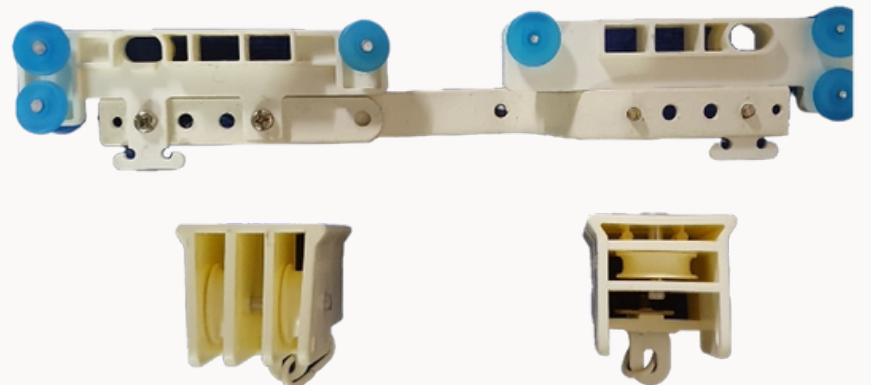

Jumbo Track Overlapper

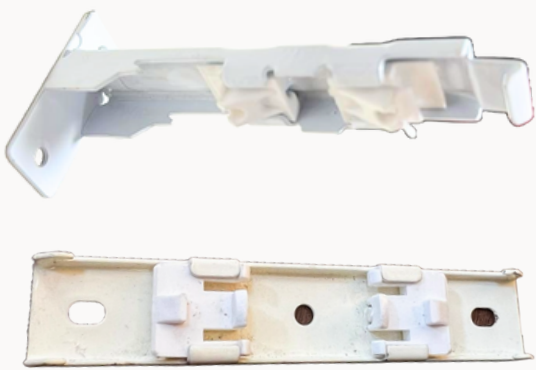

Jumbo Double Brackets



Jumbo Jointer



Jumbo Magnet

WEIGHT OPTIONS:

**1KG/1.3KG
PER 15FT**

**CUSTOM LENGTH UP TO 16FT
AVAILABLE AGAINST ORDER**

JUMBO SILENT TRACK

Ivory

Antique

Rose Gold



Jumbo Blue Runner

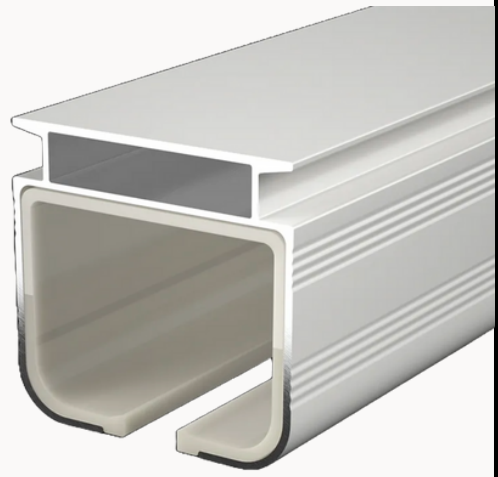

Jumbo Ivory Runner

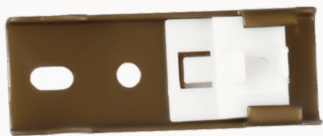

Colored Jumbo Bracket



Jumbo Bracket (#28)

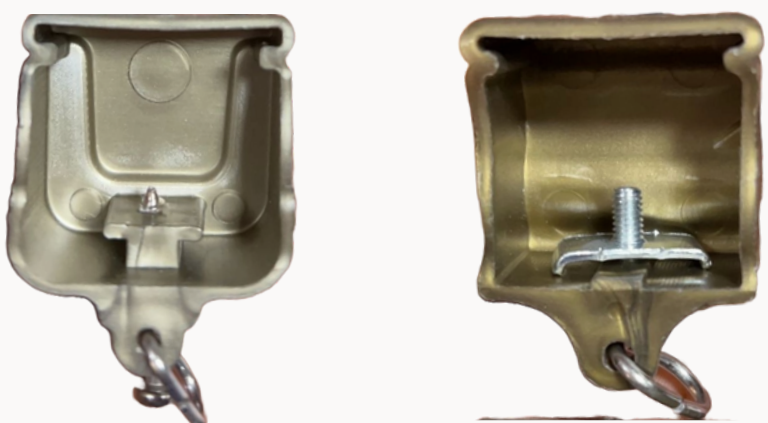

Jumbo End Cap (Normal/Screw)

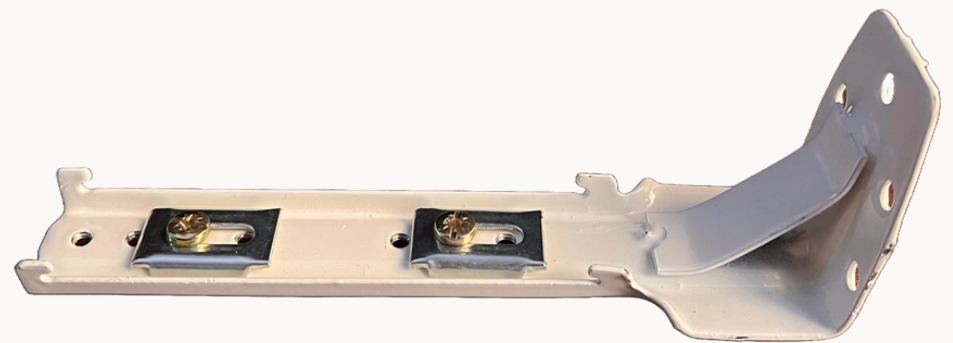

**Universal Double Wall (Heavy)
Available in all colours**



**Universal Brackets
Available in all colours**

HOSPITAL CURTAIN TRACK

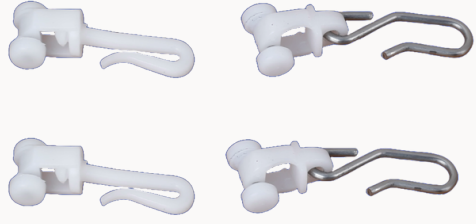

Runner (Pvc Hook/SS Hook)



Jointer



Extension Pipe
(12mm/15mm)

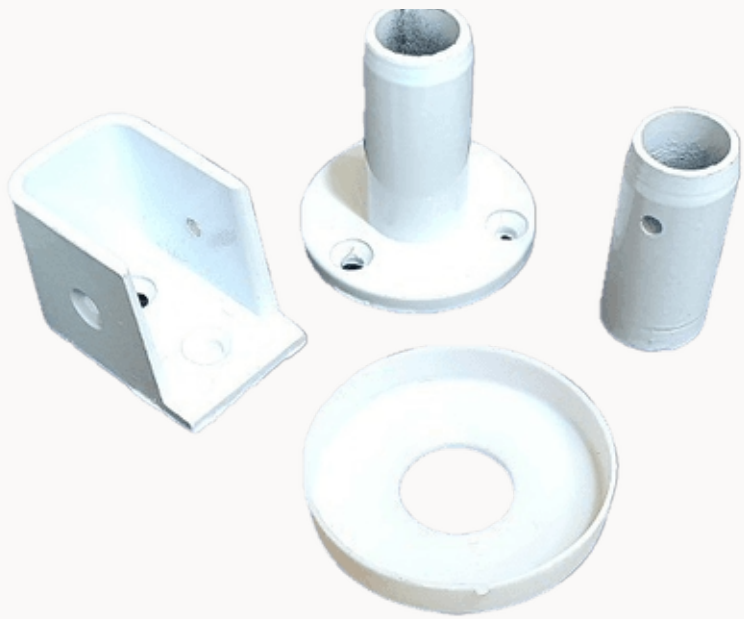

Hospital Aluminum Set



Hospital PVC Set



Hospital Metal Set



WEIGHT DETAILS:

**2.2 KG
PER 16FT**

8X8 Bended Channel Availab;e

**Manual Bending
Machine Also Available**

RJ RIPPLE TRACK

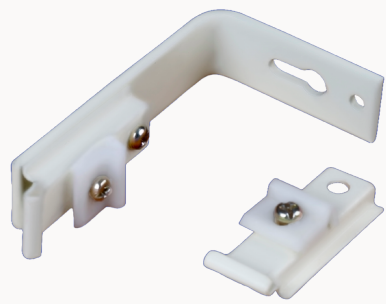

Ripple Ceiling/Wall Bracket



RJ Ripple Track

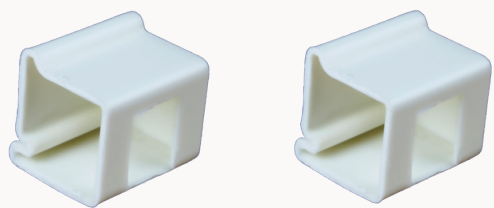

Ripple End Cap



Ripple Runner

ARABIAN RIPPLE-FOLD



Ripple Arabian Runner



Arabian Ripple Track

UNIVERSAL RIPPLE-FOLD

Compatible with ALL type of Curtain Tracks like M Track, Jumbo Track, Deluxe track and many more models



Runner with Complimentary
Double Hook Carrier



Tape

MEGA DELUXE TRACK

Electrophoresis
Colour
Coating



Rose Gold



Matte Grey



Matte Black



Champagne



Light Ivory

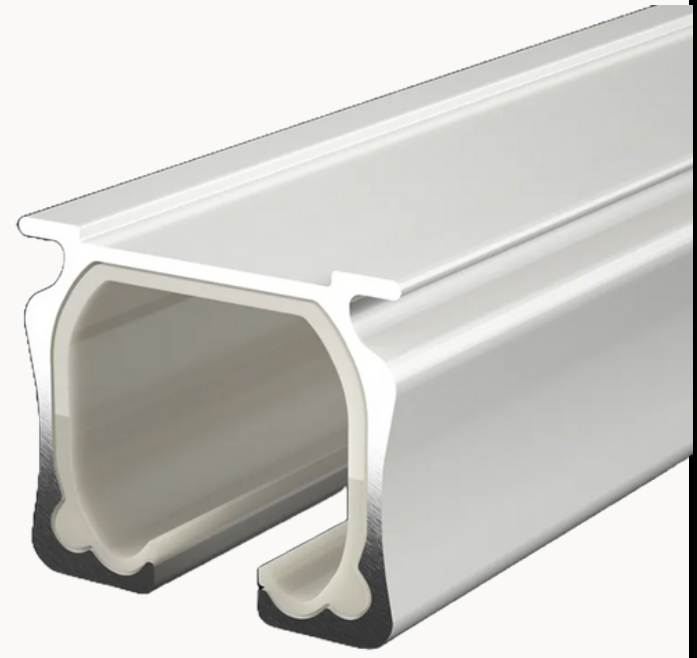

1.8kg/15 Ft



Deluxe Runner



Deluxe End Cap (Metal)



Ceiling Bracket



Wall Bracket

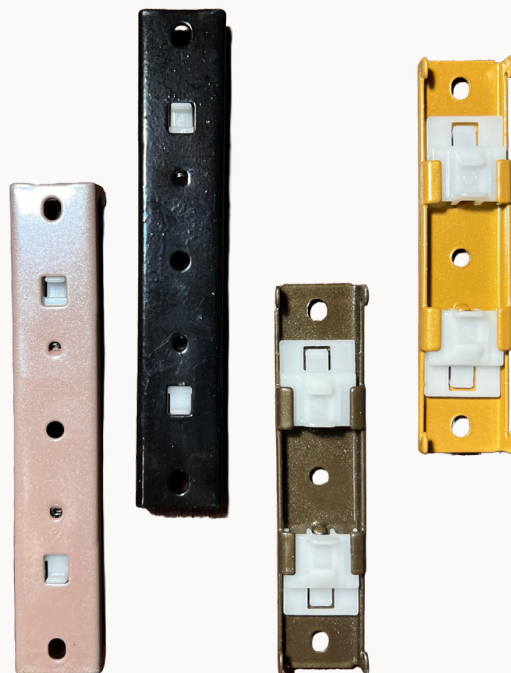

Double Ceiling



Double Wall

ULTIMA TRACK

Electrophoresis
Colour
Coating



ROSE GOLD



IVORY



MATE BLACK



CHAMPAGNE

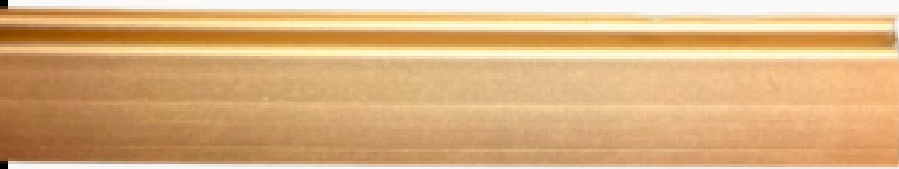

GOLD



850gm/15 Ft



Deluxe Runner



Deluxe End Cap (Metal)

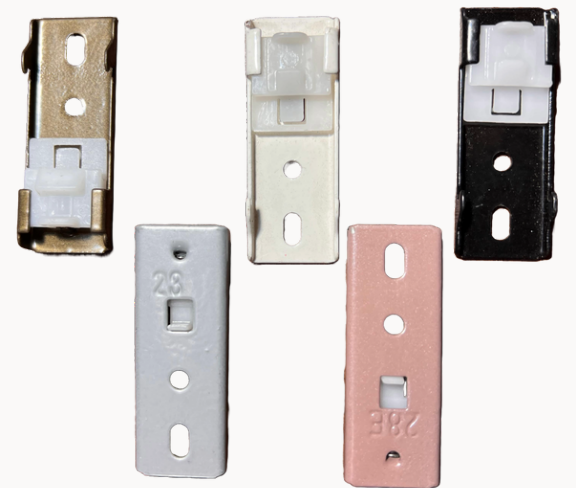

Ceiling Bracket



Wall Bracket

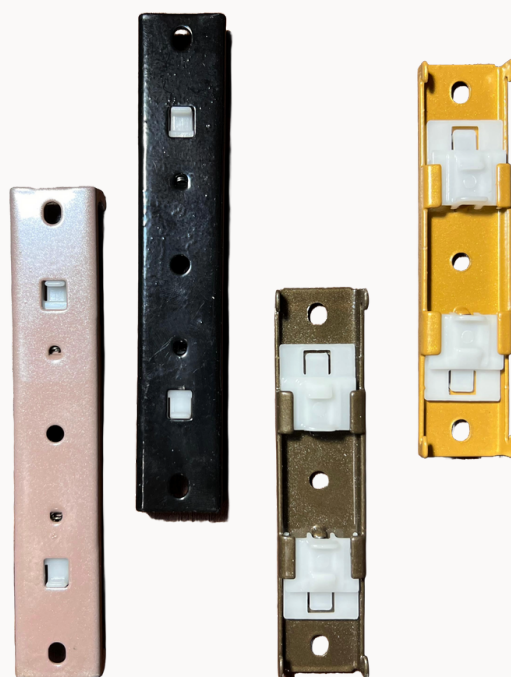

Double Ceiling



Double Wall

FLEXI TRACK

MANUAL BENDING PREMIUM CHANNEL

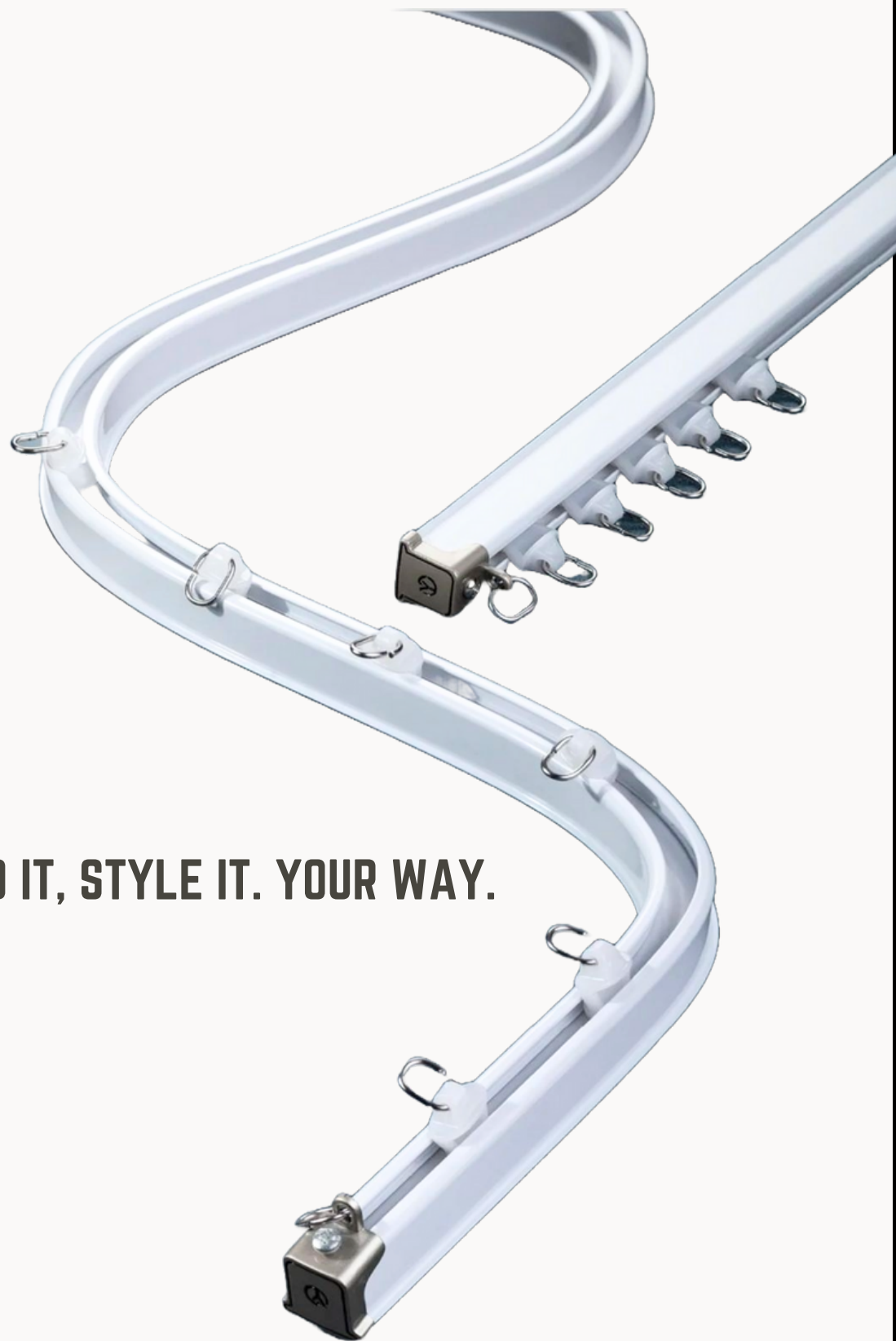
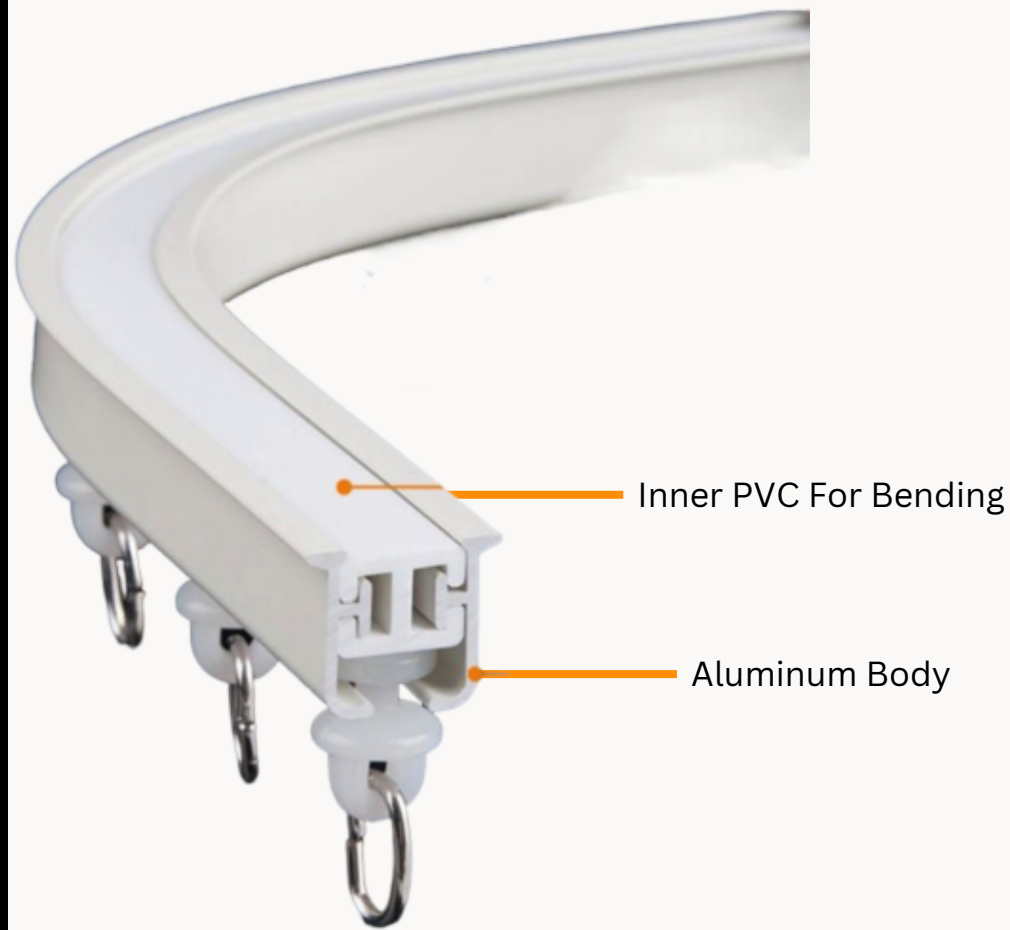

BEND IT, STYLE IT. YOUR WAY.



Flexi Metal End Cap



Flexi Runner

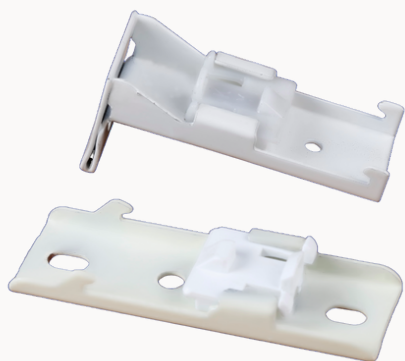

Flexi Ceiling and Wall Bracket

- PVC Infused Manual Bending Track
- 90 Degree plus bend can be done manually
- Track Weight : 1kg/15Ft
- Demo:
<https://shorturl.at/aim34>

MINI SILENT TRACK

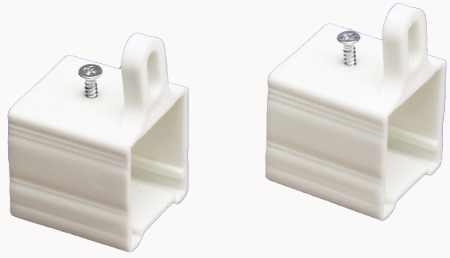

Mini Silent End Cap



Mini Runner

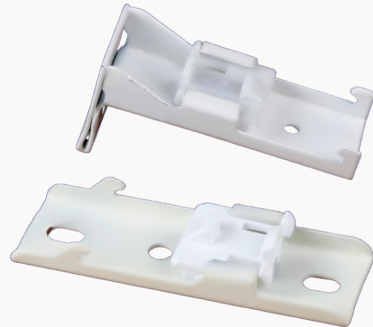

Mini Silent Brackets

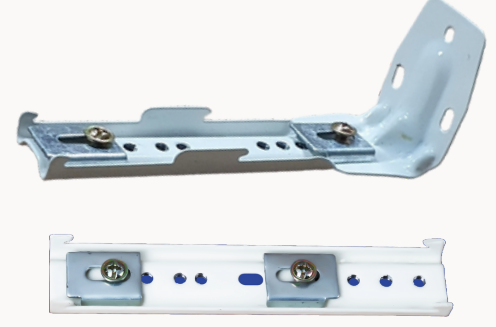

Double Ceiling/Wall

SLEEK M TRACK



Sleek M End Cap

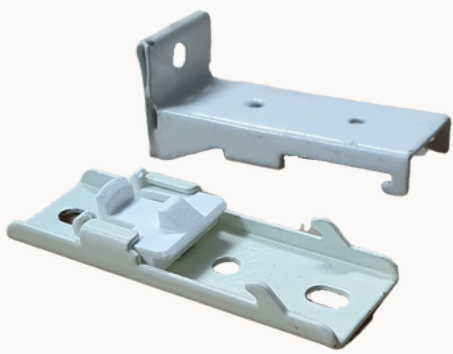

Sleek M Brackets



Sleek M Runner

POWER TRACK

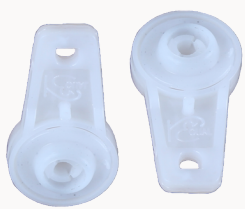

Power Track Runner

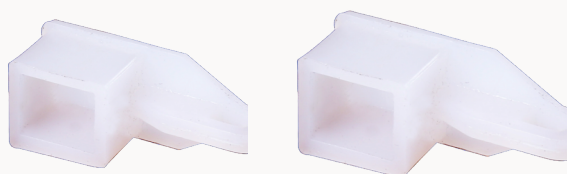
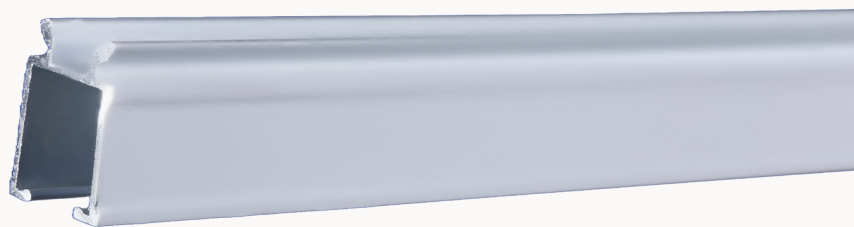

Power Track End Cap

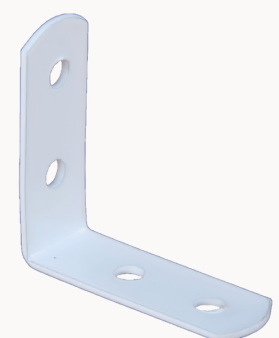

L Bracket

BENDABLE I TRACK

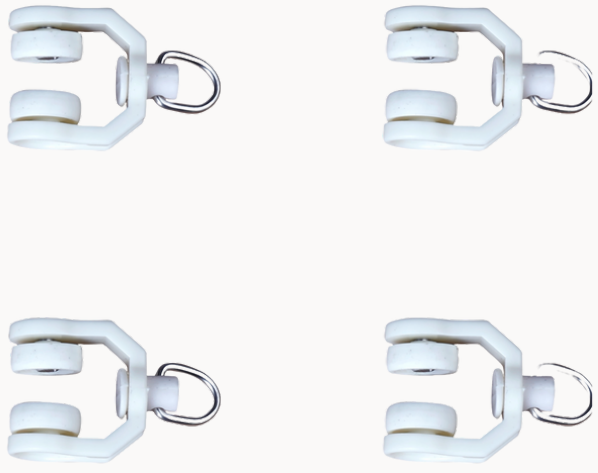

I Runner

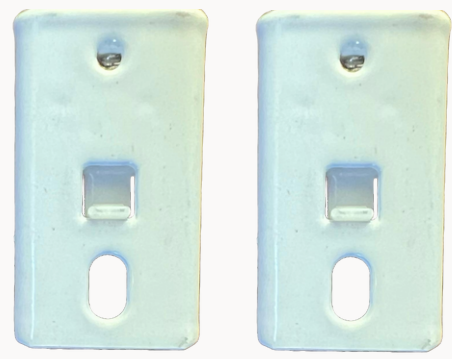

I Ceiling Bracket

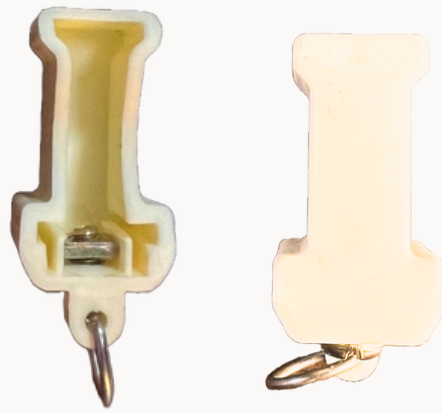

I Track End Cap

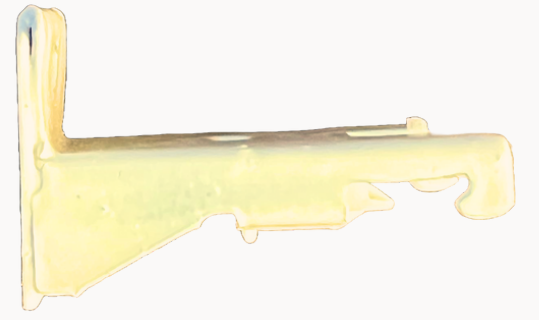

I Wall Bracket

MINI I TRACK

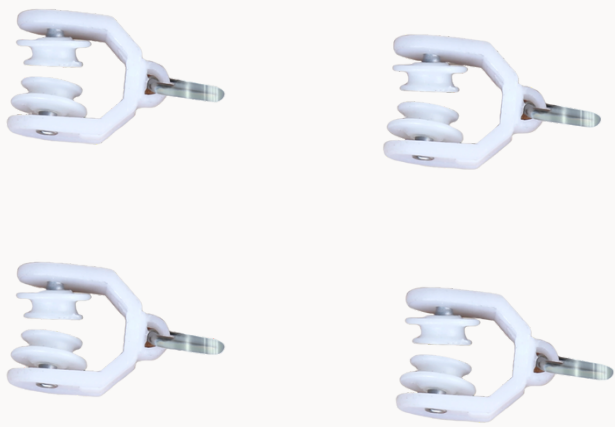

Mini I Track Runner



Mini I Track Brackets



Mini I Track End Cap

CURTAIN MOTOR (DOOYA)



Models Available

- 3 Wire Remote (100kg Load)
- 4 Wire Automation (100kg)
- 5 Wire Wifi (50kg Load)

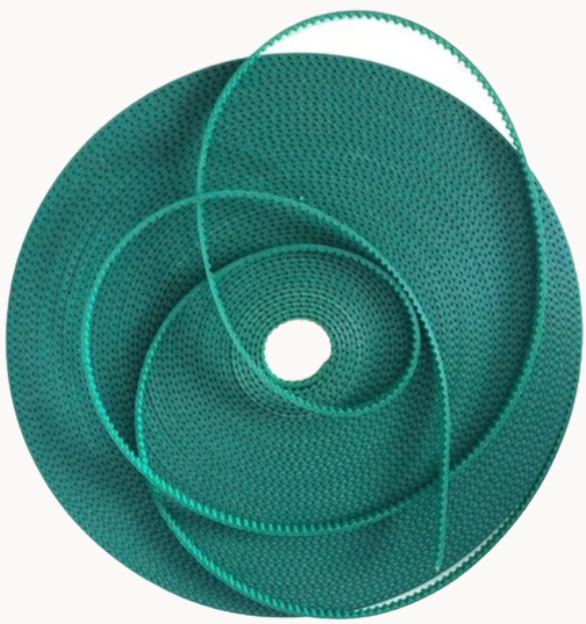

Motorized Belt

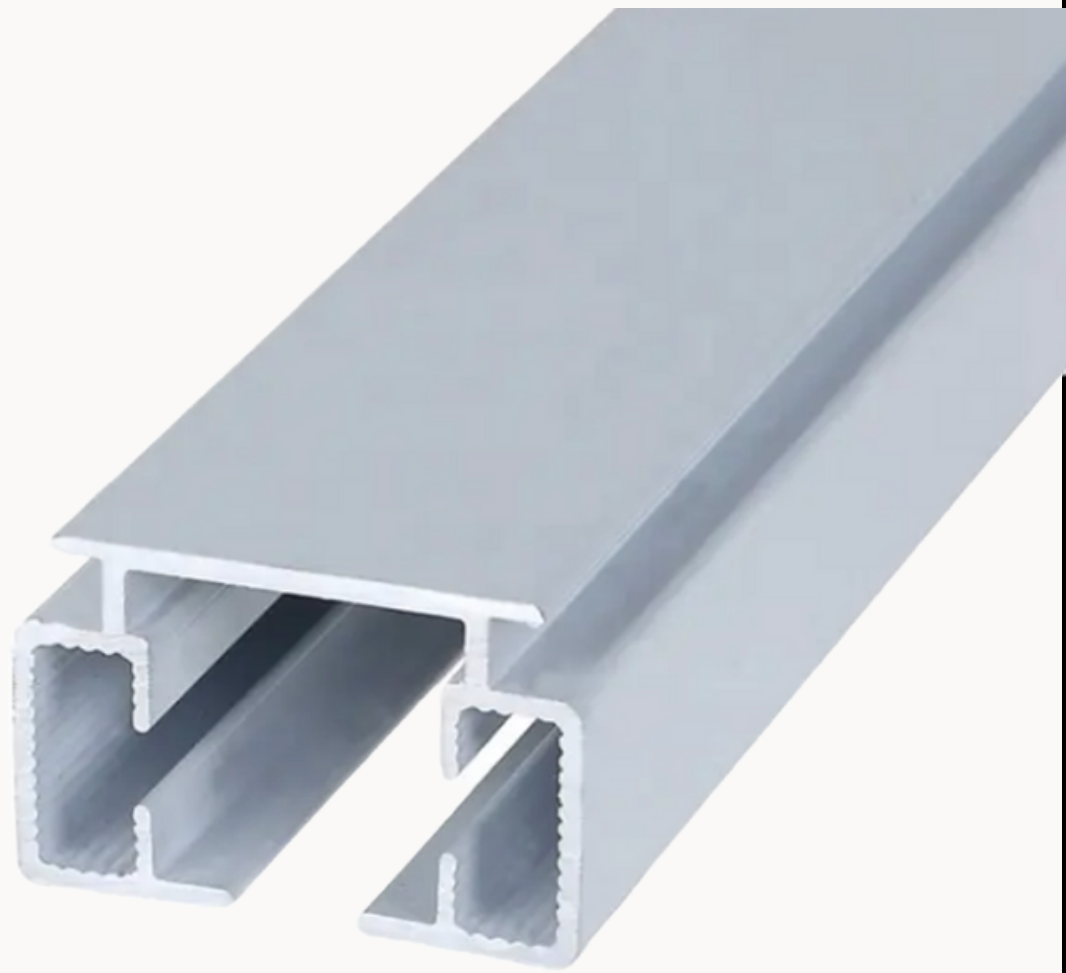

Motorized Track(Dooya)

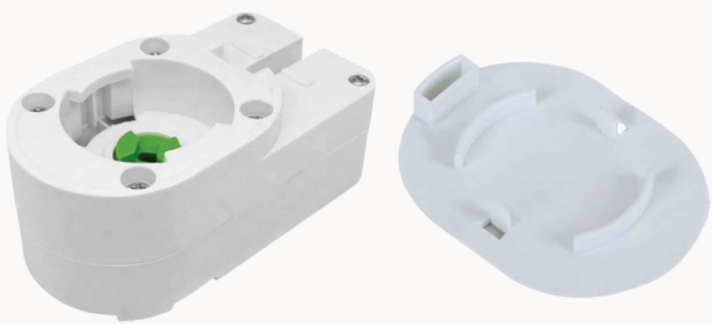

3 Wire End Cap (With Cover)

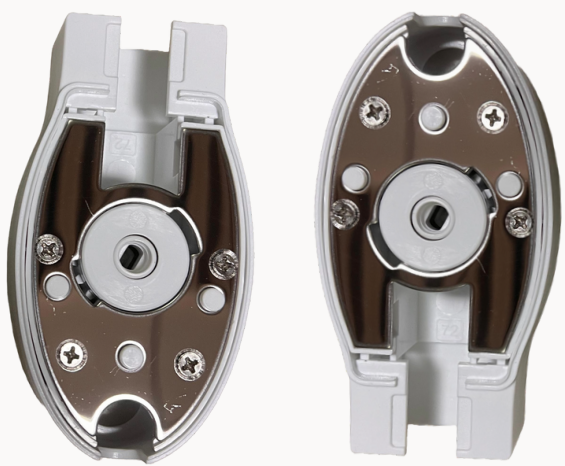

5 Wire End Cap (Metallic)



Motorized Ripple Runner and Belt



Motorized Overlapper



Connection Part

Blind Components



ROMAN BLINDS CHANNEL

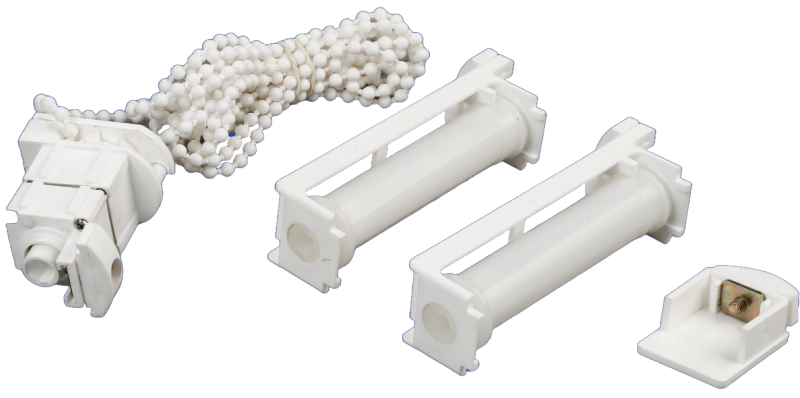

Roman Long Pulley Set



Solid/Hollow Rod Inside



Roman Transparent Set



Double Roman Channel



Roman Black Set



Roman RJ Spl Set (3 Pulley)

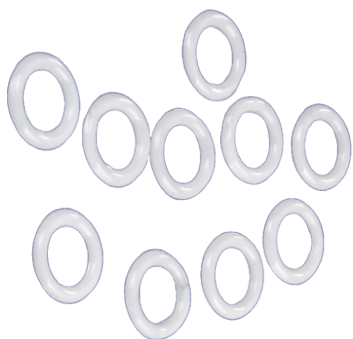

Roman O Ring

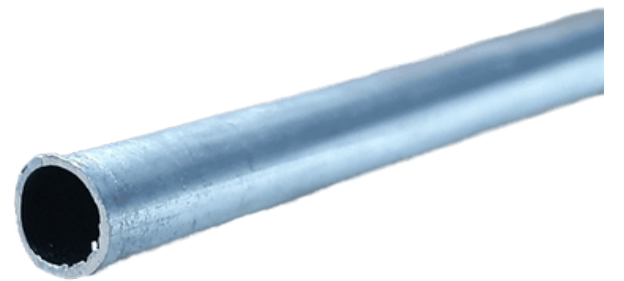

9MM Pipe (12Ft/15Ft)



**Roman Blackout Pipe
(Non-Stitch)**



Roman Cord Imported (0.9mm)

ROMAN TUBELIGHT CHANNEL

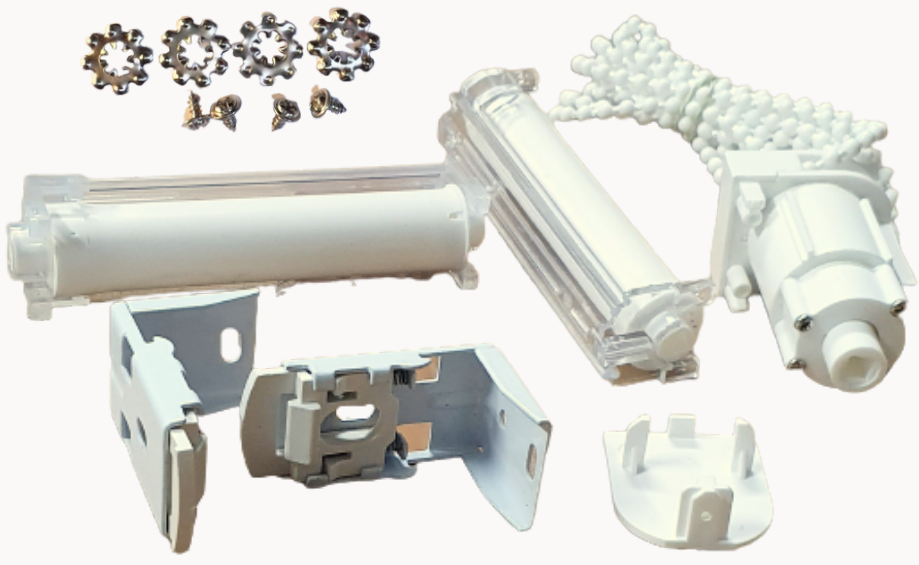

Tubelight Set Heavy

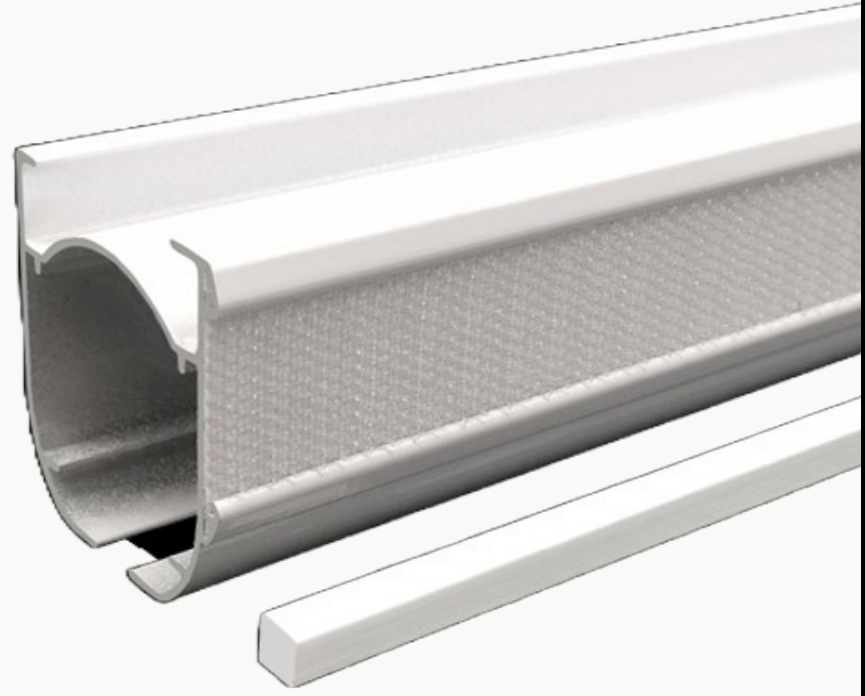

Tubelight Set Light

ROMAN TUBELIGHT CHANNEL(NEW)



New Tubelight Set Heavy



ROMAN ONE-TOUCH CHANNEL

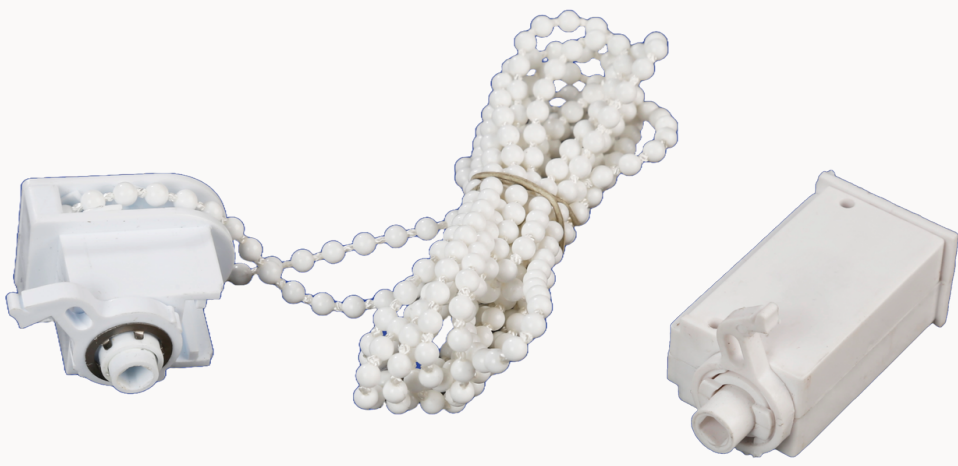

Roman One-Touch Set



ZEBRA BLINDS

White

Ivory

Brown



Zebra Set (Light)



Zebra Set (Heavy)



Set of 4 (Model 1)



Set of 4 (Model 2)

ROLLER BLINDS



Roller PVC Bottom

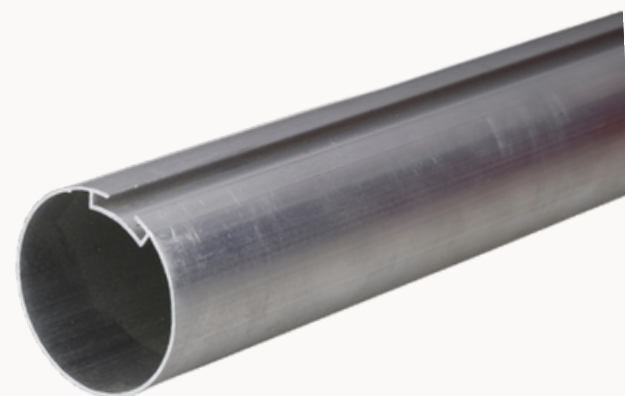

38mm Top Channel

ROLLER BLINDS CONTROL SETS



Roller Set Light
3 Springs



Roller Set Black
4 Springs



Roller Set Heavy
3 Springs + Gear



Roller Set Heavy Square
4 Springs + Gear

ROLLER BOTTOM RAILS

White

Ivory

Brown



New U Bottom



Flat Bottom



Universal Bottom

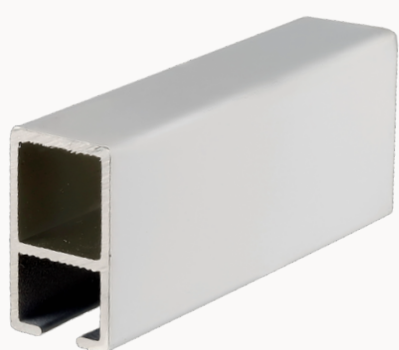

Square Bottom

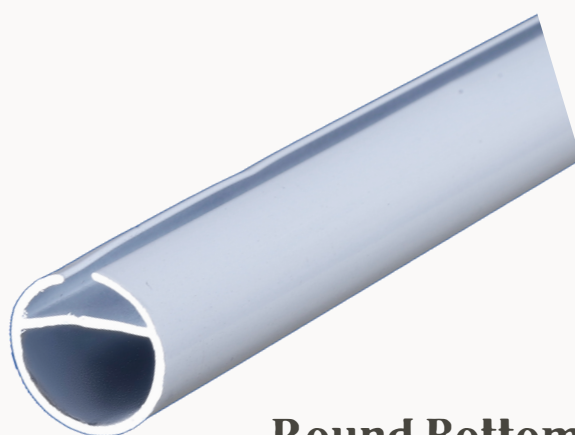

Round Bottom

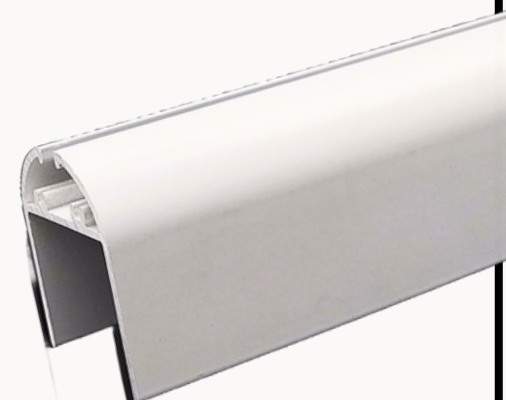

U Bottom

VERTICAL BLINDS



4.5*6mm Chain

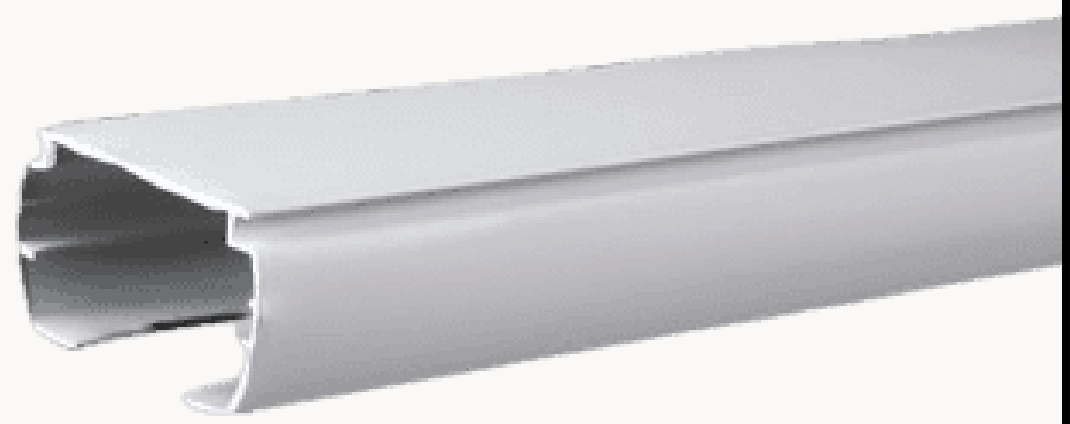

Vertical Round



End Cap



Brass Bush



Vertical Marvel



Vertical Ceiling Bracket

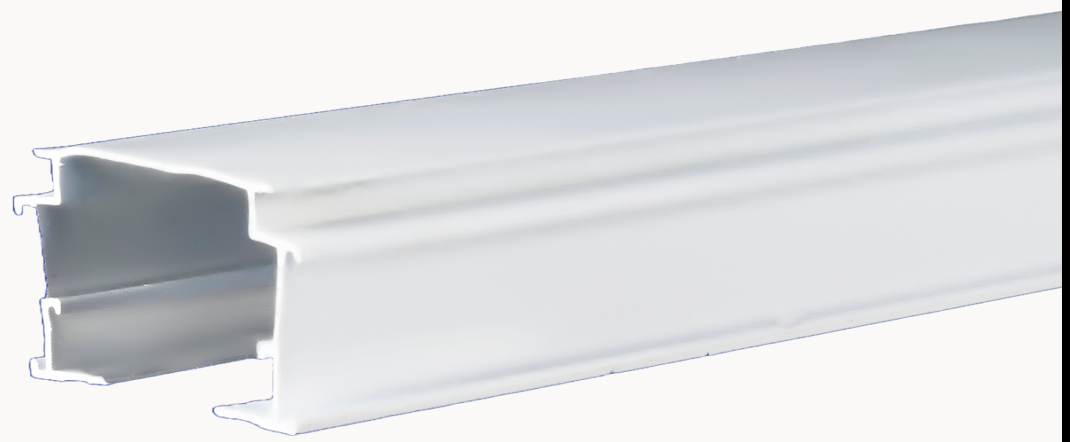

Vertical Vista



PVC / Iron Bottom Weight



Runner-Spacer-Hanger



Operation and Bottom Chain



Master Runner



Cord Weight 01



Cord Weight 02



Cord Weight 03

WOOD VENITIAN BLINDS



VT-01



VT-02

PANEL BLINDS

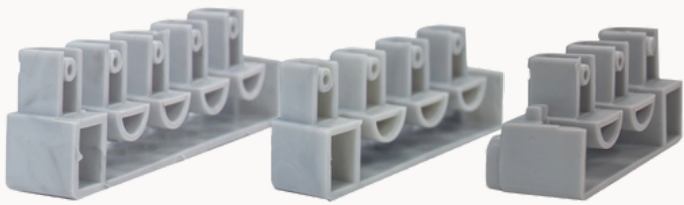

End Cap

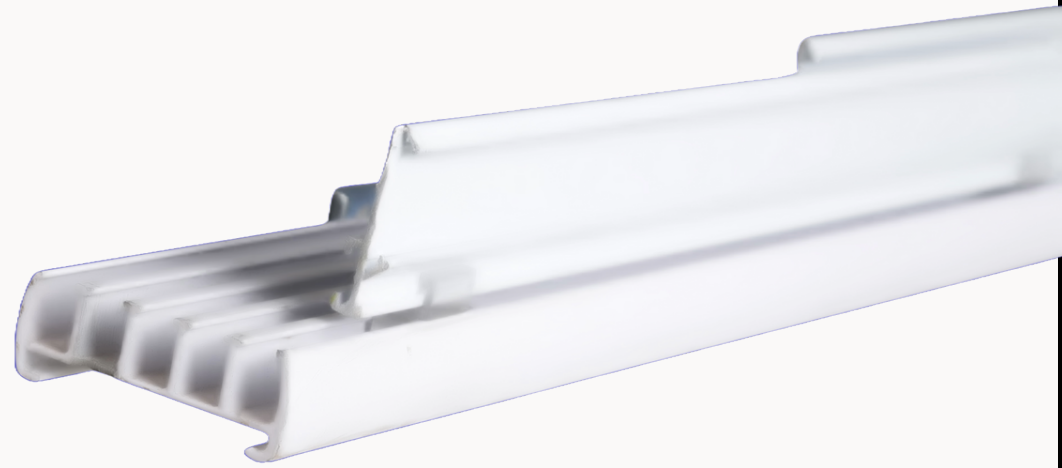

Panel Track



1.8mm Cord

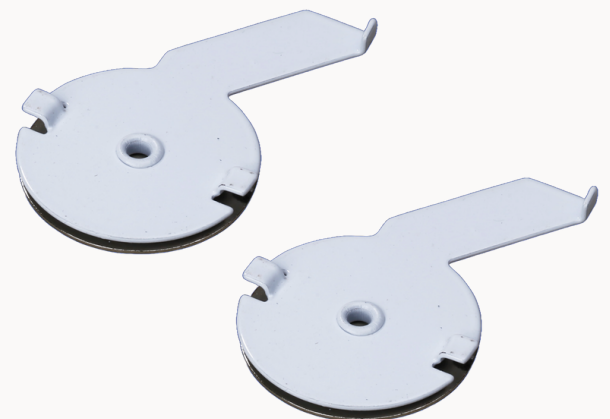

Ceiling Clamp

BAMBOO BLINDS SET (IMPORTED).

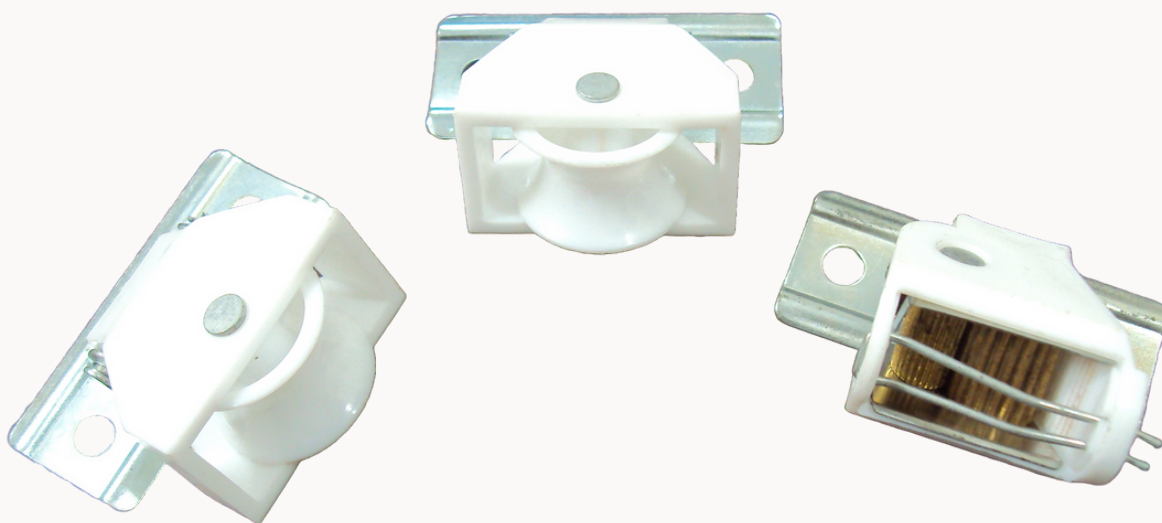

CURTAIN ACCESSORIES

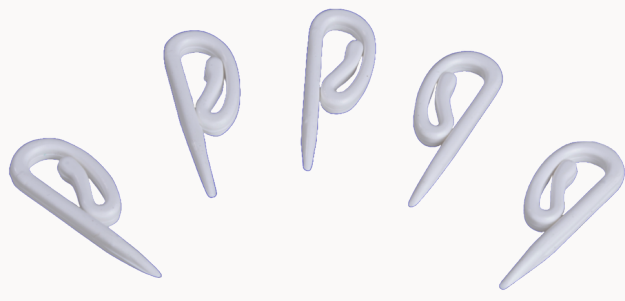

PVC J Hook

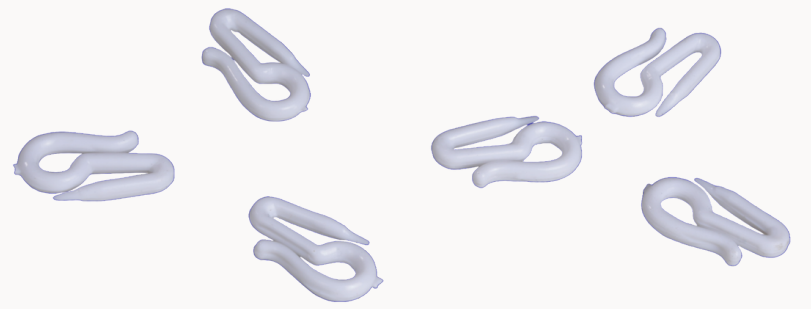

PVC S Hook



Ripple Universal Runner
(Compatible with ALL curtain tracks)



Blinds Control Chain
Multiple Sizes

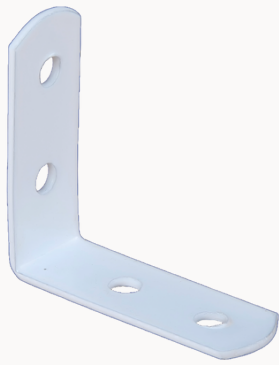

L Bracket (All Sizes)



Bottom Weight Chain

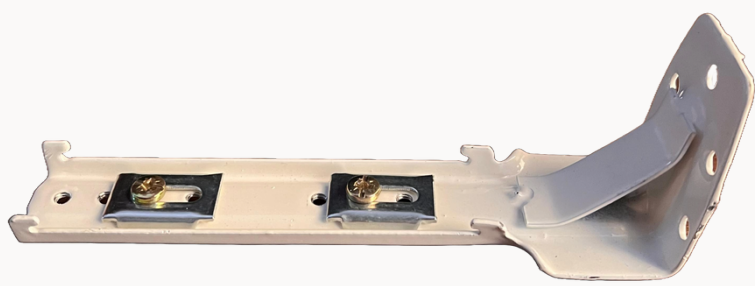

Universal Double Wall (Heavy)
Available in All Colours

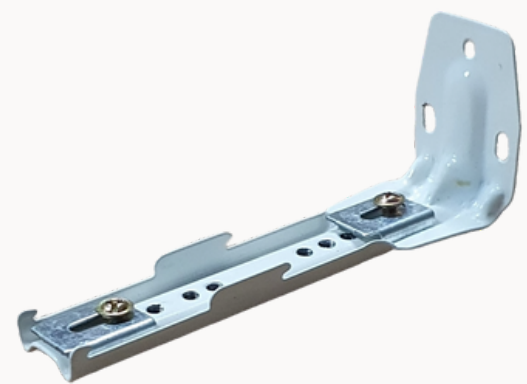

Universal Wall Bracket



Universal Ceiling Bracket



Adjustable Shower Rod

Available in
1.25 and 1.5m

CURTAIN WANDS



White



maple



teak



transparent

ROD BRACKETS



Long Bracket



Vista Bracket



SS Bracket
(Heavy, Med. & Light)



SS Double Long Bracket



Jaguar Bracket

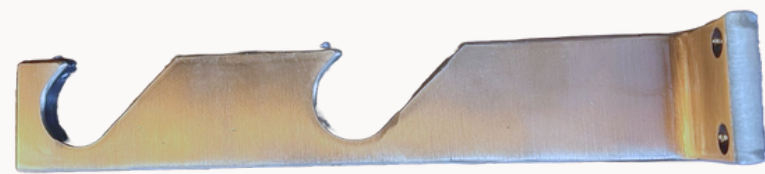

Single/Double American

CURTAIN TAPES

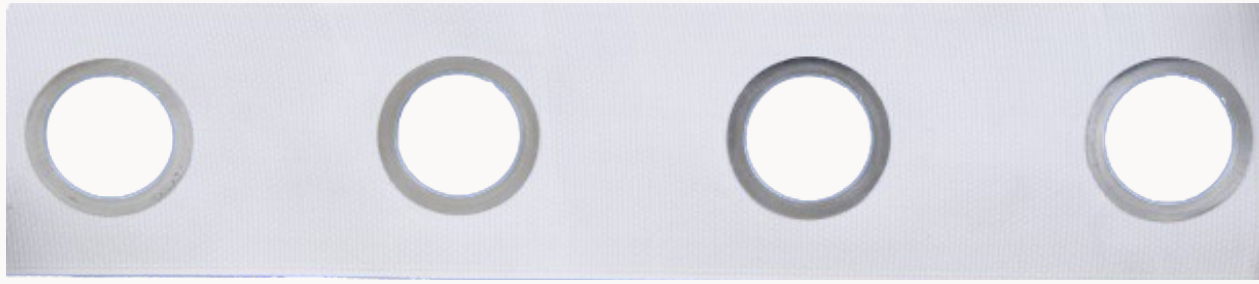

Aluminum Eyelet Ring Tape

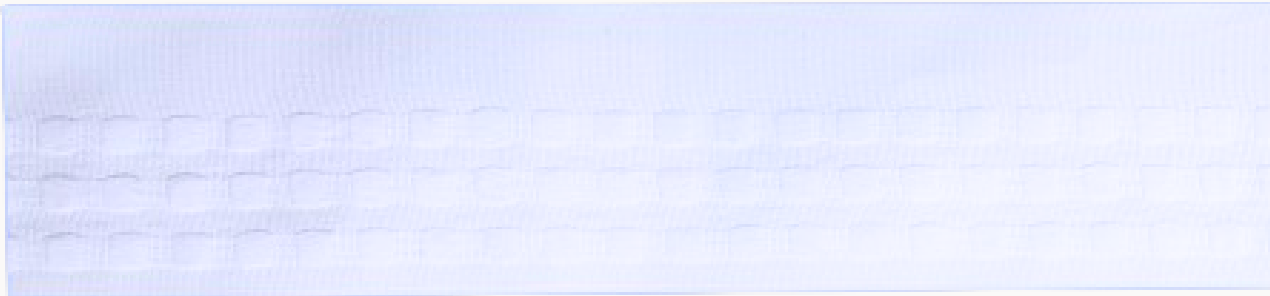

Hook Tape (1.4kg/1.6kg)

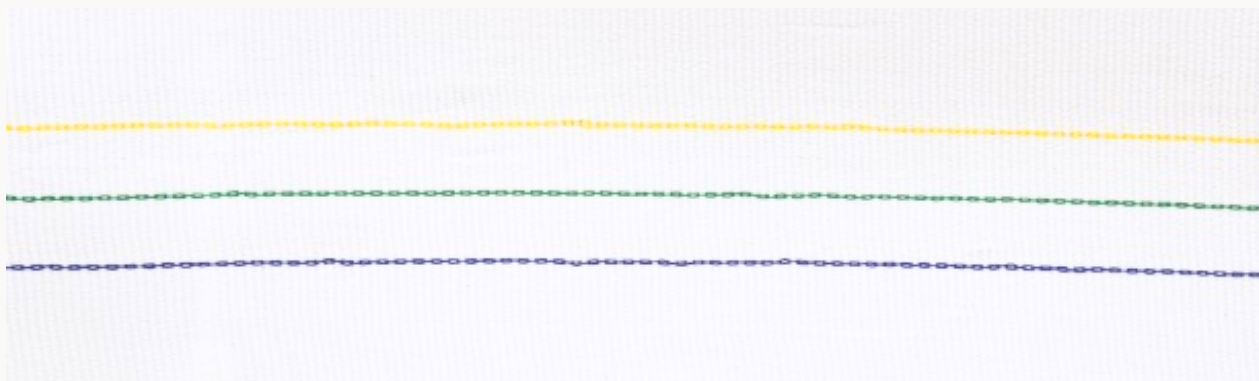

Tri-colour Tape

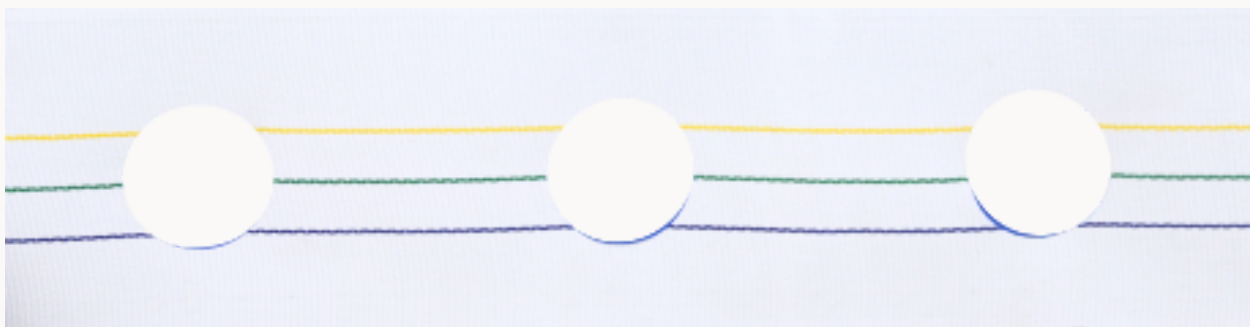

Tri-colour Tape with Hole



Plain Tape with Hole



Plain Tape



THANK
YOU

GET IN TOUCH

We at Decor Home Studio would love to get in touch with you to discuss your sourcing needs and build a conducive partnership in the near future

PHONE NUMBER

9971 117 508

LOCATION

03, Radha Krishna Market, Opp. Gaur City 14th Avenue
High Street, Greater Noida West, UP-201009